

Model No.HP002G CORDLESS HAMMER DRIVER DRILL

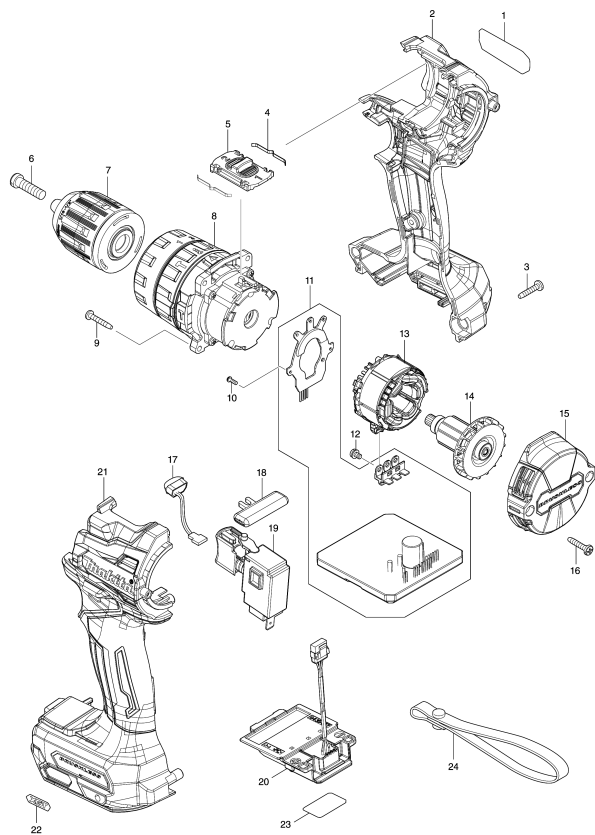

Model No.HP002G CORDLESS HAMMER DRIVER DRILL

Item	Parts No.	Description	I/C	Qty	New/Old	Opt. 1	Opt. 2	Note
001	858C81-4	HP002G NAME PLATE		1				
002	183S03-4	HOUSING SET		1				
C10	263005-3	RUBBER PIN 6		2				
C20	252126-6	HEX. LOCK NUT M4-7		2				
D10		INC. 21						
003	266429-2	TAPPING SCREW 3X16		7				
004	232493-5	LEAF SPRING		2				
005	127731-7	SPEED CHANGE LEVER ASSEMBLY		1				
C10	233438-6	COMPRESSION SPRING 4		2				
006	251468-5	- FLAT HEAD SCREW M6X22		1				
007	763256-3	KEYLESS DRILL CHUCK 13		1				
008	127729-4	GEAR ASSEMBLY		1				
009	251497-8	TAPPING SCREW 3X20		4				
010	266490-9	TAPPING SCREW PT 2X6		3				
011	620E42-4	CONTROLLER		1				
012	652069-6	FLAT HEAD SCREW M3X6		3				
013	629A35-4	STATOR		1				
014	619659-8	ROTOR		1				
015	413251-0	REAR COVER		2				
016	266429-2	TAPPING SCREW 3X16		1				
017	620549-0	LED CIRCUIT		1				
018	419041-9	F/R CHANGE LEVER		1				
019	651443-5	SWITCH C3JR-4B		1				
020	632R99-1	TERMINAL UNIT		1				
021	183S03-4	HOUSING SET		1				
C10	263005-3	RUBBER PIN 6		2				
C20	252126-6	HEX. LOCK NUT M4-7		2				
D10		INC. 2						
022	8007R2-2	XGT LOGO LABEL		1				
023	858C88-0	HP002G SERIAL NO. LABEL		1				
A01	251314-2	+ SCREW M4X12		1				
A02	346317-0	HOOK		1				
A03	784637-8	+- BIT 2-45		1				
A04B	***DC40RA	DC40RA FAST CHARGER		1				
D10		COMPO-PARTS						
A05B	191B36-3	BATTERY BL4025 SET		2				
A06B	412393-7	BATTERY COVER		1				
A07B	821550-0	CONNECTOR PLASTIC CASE (TYPE2)		1				
C10	453974-8	LATCH		4				
A08B	835U77-0	INNER TRAY		1				
A09B	8028H1-6	HP002GD201 INDICATION LABEL		1				

Please order the parts with part number.

Print Date 14/1/2021

Model No.HP002G CORDLESS HAMMER DRIVER DRILL

Item	Parts No.	Description	I/C	Qty	New/Old	Opt. 1	Opt. 2	Note
A10B	8028H2-4	HP002GD201 PLASTIC CASE LABEL		2				

Please order the parts with part number.

Print Date 14/1/2021