

Model No.M0600 10MM DRILL

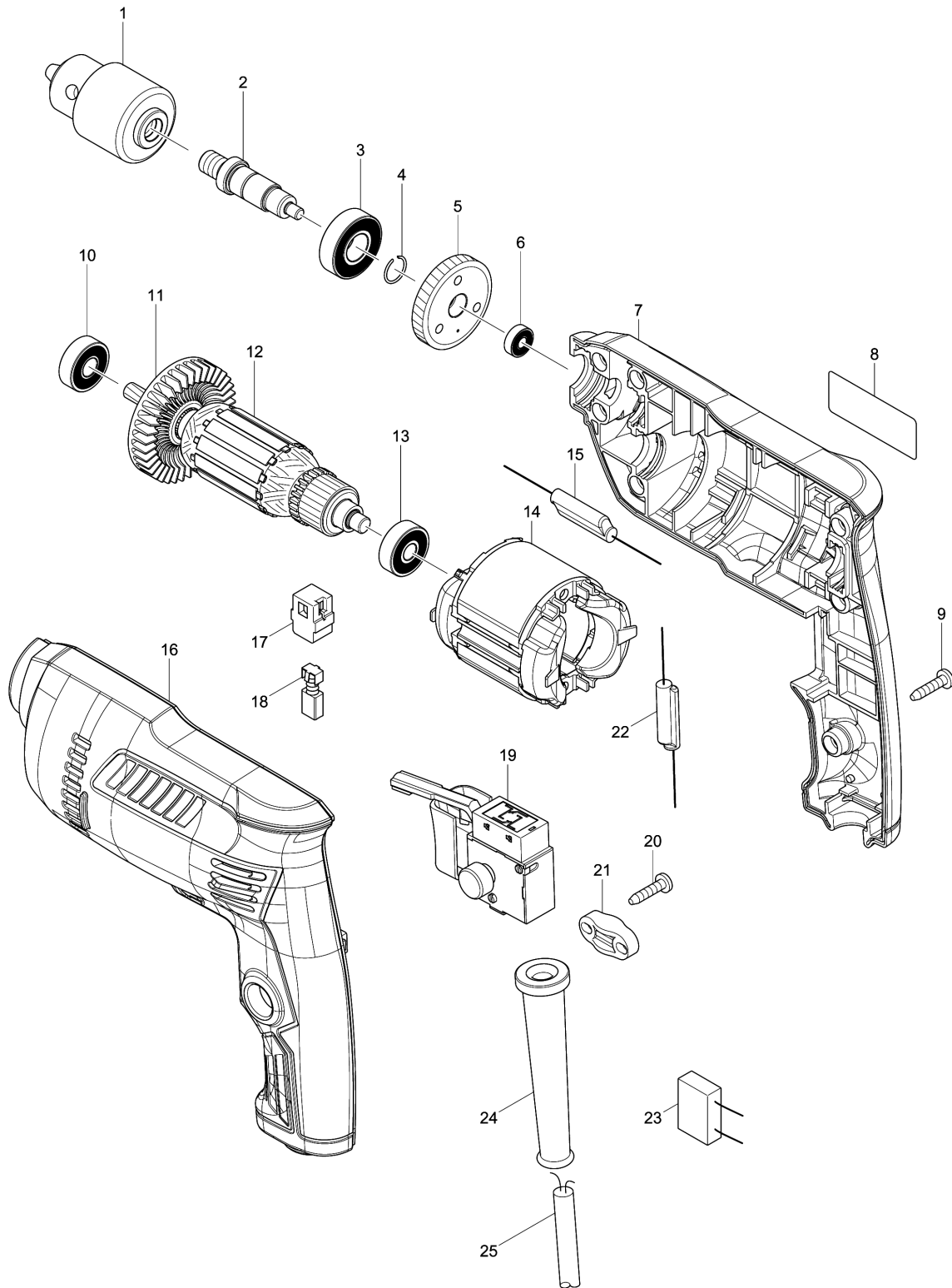

Model No.M0600 10MM DRILL

Item	Parts No.	Description	I/C	Qty	New/Old	Opt. 1	Opt. 2	Note
001	766014-6	DRILL CHUCK S10		1				
002	326025-9	SPINDLE		1				
003	210119-9	BALL BEARING 6001ZZ		1				
004	233950-6	RING SPRING 11		1				
005	227742-3	HELICAL GEAR 35		1				
006	210137-7	BALL BEARING 606ZZ		1				
007	183B21-0	HOUSING SET		1				
D10		INC. 16						
008	851A82-9	M0600 NAME PLATE		1	*			
008-1	851A82-9	M0600 NAME PLATE	O	1				
009	266326-2	TAPPING SCREW 4X18		7				
010	210046-0	BALL BEARING 608ZZ		1				
011	240127-6	FAN 52		1				
012	515834-3	ARMATURE ASS'Y 240V		1				
D10		INC. 10,11,13						
013	210050-9	BALL BEARING 627ZZ		1				
014-1	633989-3	FIELD		1				
015	646230-5	CHOKE COIL		1	*			
015-1	646153-7	CHOKE COIL	O	1				
016	183B21-0	HOUSING SET		1				
D10		INC. 7						
017	643566-3	BRUSH HOLDER 5X8		2				
018	191627-8	CARBON BRUSH CB-64		1				
019	650240-6	SWITCH FA2-4/1BEK		1				
020	266326-2	TAPPING SCREW 4X18		2				
021	687124-5	STRAIN RELIEF		1				
022	646231-3	CHOKE COIL		1	*			
022-1	646147-2	CHOKE COIL	O	1				
023	645273-4	NOISE SUPPRESSOR		1	*			
023-1	645190-8	NOISE SUPPRESSOR	O	1				
024	682582-0	CORD GUARD		1				
025-1	695556-2	POWER SUPPLY CORD 1.0-2-2.0		1	*			
025-2	665383-1	POWER SUPPLY CORD 1.0-2-2.0	O	1				
A01	763447-6	CHUCK KEY S10		1				

Please order the parts with part number.

Print Date 2/6/2022